

SL-SPOT06-WW3W-ZN75

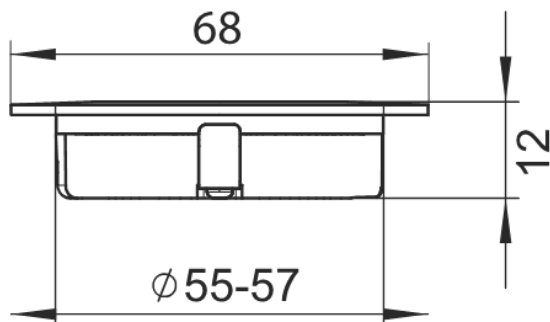

Technical drawing



Type of light source:

Lighting technology used:
LED

Non-directional or directional:
NDLS

Mains or non-mains:
NMLS

Connected light source (CLS):
no

Colour-tuneable light source:
no

Envelope:
no

High luminance light source:
no

Anti-glare shield:
no

Dimmable:
yes

Product parameters:

Energy consumption in on-mode (kWh/1 000 h):
3

Energy efficiency class:
G

Useful luminous flux:
220 lumen (Sphere (360°))

Correlated colour temperature:
3000K

On-mode power (P_{on}) in W:
3

Standby power (P_{sb}) in W:
0

Networked standby power (P_{net}) for CLS in W:
0

Colour rendering index:
85

Outer dimensions (length | width | height):
68 mm | 68 mm | 12 mm

Energy Label

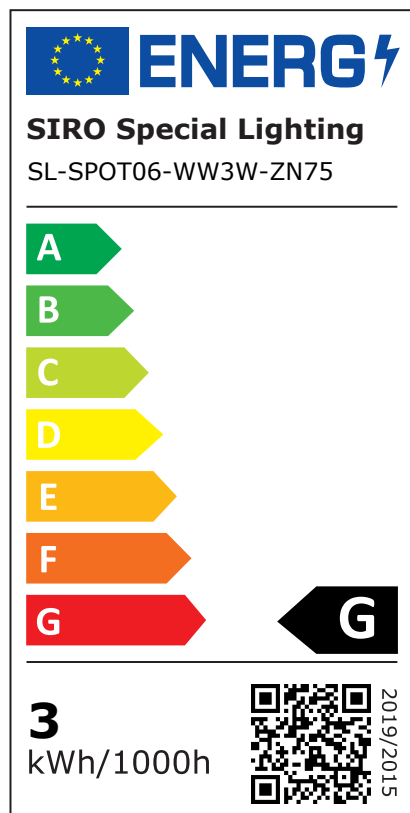

Installation diameter:
55.0 mm

Installation depth:
12.0 mm

Connection cable:
2000 mm

IP protection class:
ip44ip20

Division every mm:
-

External heat sink required:
no

Number of LEDs per metre:
-

Operating temperature:
-

Storage temperature:
-

Net weight:
37 g

EAN Code:
9002843422774

Claim of equivalent power:
no

If yes, equivalent power (W):
-

Chromaticity coordinates (x | y):
0,453 | 0,405

Parameters for directional light sources:

Peak luminous intensity (cd):
-

Beam angle:
110 °

Spectral power distribution:

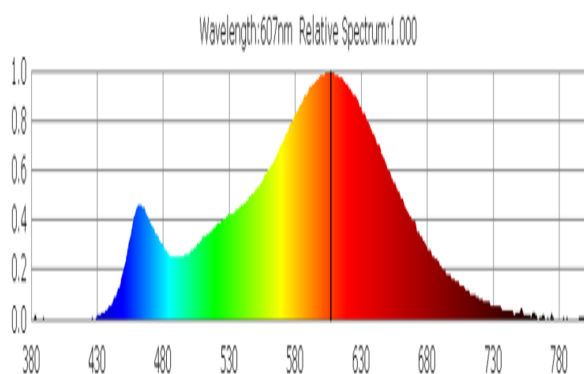

Parameters for LED and OLED light sources:

R9 colour rendering index value:
10

Survival factor:
1

lumen maintenance factor:
0,94

L70B50-Lifespan:
30000 h

Parameters for LED and OLED mains light sources:

displacement factor (cos ϕ):
-

Colour consistency in McAdam ellipses:
-

LED replaces fluorescent light source:
no

If yes then replacement claim (W):
-

Flicker metric (Pst LM):
-

Stroboscopic effect metric (SVM):
-

Safety and installation instructions:

- >> This product is not a toy and is not suitable for children!
- >> The assembly must be carried out free of voltage!
- >> Do not mount the LED strips / plugs / cables on moving parts, free from tensile and torsional forces. Avoid mechanical stresses such as kinking, bending or chafing!
- >> The SIRO LED system is only suitable for indoor use. Unprotected use outdoors is not permitted. Contact with moisture must be avoided at all costs!

